



저작자표시-비영리-변경금지 2.0 대한민국

이용자는 아래의 조건을 따르는 경우에 한하여 자유롭게

- 이 저작물을 복제, 배포, 전송, 전시, 공연 및 방송할 수 있습니다.

다음과 같은 조건을 따라야 합니다:



저작자표시. 귀하는 원저작자를 표시하여야 합니다.



비영리. 귀하는 이 저작물을 영리 목적으로 이용할 수 없습니다.



변경금지. 귀하는 이 저작물을 개작, 변형 또는 가공할 수 없습니다.

- 귀하는, 이 저작물의 재이용이나 배포의 경우, 이 저작물에 적용된 이용허락조건을 명확하게 나타내어야 합니다.
- 저작권자로부터 별도의 허가를 받으면 이러한 조건들은 적용되지 않습니다.

저작권법에 따른 이용자의 권리는 위의 내용에 의하여 영향을 받지 않습니다.

이것은 [이용허락규약\(Legal Code\)](#)을 이해하기 쉽게 요약한 것입니다.

[Disclaimer](#)

A MASTER THESIS

Application of DBD plasma treatment on
surface modification of fuel cell stack at
atmospheric pressure

SURESH RAI

DEPARTMENT OF NUCLEAR AND ENERGY ENGINEERING

GRADUATE SCHOOL
JEJU NATIONAL UNIVERSITY

August, 2014

Application of DBD plasma treatment on surface modification of fuel cell stack at atmospheric pressure

Suresh Rai

(Supervised by Professor Heon-Ju Lee)

A thesis submitted in partial fulfillment of the requirement for the degree of

Master of Science

2014-06-17

This thesis has been examined and approved

이 현주 

Thesis director

Professor Heon-Ju Lee, Nuclear and Energy Engineering



Professor Won-Gee Chun, Nuclear and Energy Engineering



Professor Young-Sun Mok, Chemical and Biology Engineering

Date 2014.06

Department of Nuclear and Energy Engineering

GRADUATE SCHOOL

JEJU NATIONAL UNIVERSITY



TABLE OF CONTENTS

TABLE OF CONTENTS	I
LIST OF FIGURES.....	III
LIST OF TABLES.....	IV
ABBREVIATIONS	V
ABSTRACT	VI
CHAPTER I.....	1
INTRODUCTION.....	1
1.1 Brief Introduction.....	1
1.2 Dielectric Barrier Discharge (DBD) at Atmospheric Pressure	3
1.3 Surface modifications with atmospheric plasma.....	5
1.4 Benefits and Application of surface modification (Adhesion and wettability).....	6
1.5 Fuel cell stack and Stainless steel	7
1.6 Objectives	9
1.7 Motivation for the studies	10
CHAPTER II	11
MATERIALS AND METHODS	11
1.4 2.1 Experimental set-up	11
2.1.1 Dielectric Barrier Discharge (DBD).....	11
2.1.2 Diagnostic Apparatus (instruments)	15

CHAPTER III	17
RESULTS AND DISCUSSION.....	17
3.1 EFFECT OF AGEING TIME IN AIR OF PLASMA TREATED STAINLESS STEEL.....	17
3.2 EXAMINATION OF SURFACE ROUGHNESS AFTER DBD PLASMA TREATMENT	24
CHAPTER IV	32
CONCLUSION	32
ACKNOWLEDGEMENTS	34
REFERENCES	36

LIST OF FIGURES

Figure 1. Common Dielectric- Barrier Discharge electrode configurations.....	4
Figure 2 Exploded view of Fuel cell stack	7
Figure 3. Designed & fabricated set-up for DBD plasma surface modification at atmospheric pressure.....	12
Figure 4. Typical plasma discharge on stainless steel in the gap of four mm	12
Figure 5. water-cooling system	14
Figure 6. Image of oscilloscope of I-V characteristic at 10kV supply	15
Figure 7, showing higher contact angle on untreated surface.	17
Figure 8 showing lower water contact angle on DBD plasma treated surface.	18
Figure 9. Effect of DBD plasma treatment on ageing time	20
Figure 10. Effect of DBD plasma treatment on different time durations	21
Figure 11, 3D nano surface profiler image of untreated surface.	25
Figure 12, 3D nano surface profiler image of five second DBD plasma treated surface.	25
Figure 13, 3D nano surface profiler image of ten second DBD plasma treated surface.....	26
Figure 14, 3D nano surface profiler image of 20 second DBD plasma treated surface.	26
Figure 15, 3D nano surface profiler image of 30 second DBD plasma treated surface.	27
Figure 16, 3D nano surface profiler image of 40 second DBD plasma treated surface.	27
Figure 17. XRD result of six different substrates treated on various time intervals.....	29
Figure 18. SEM images of treated and untreated stainless steel surfaces.....	30

List of Tables

Table 1 shows average water contact angle of substrate with respect to aging time (hydrophobic recovery).....	19
Table 2, showing average wetting energy of substrate with respect to aging time (hydrophobic recovery).....	19
Table 3.Surface roughness and peak to peak values of six substrates treated on different	24

ABBREVIATIONS

DBD	- Dielectric barrier discharge
FESEM	- Field emission scanning electron microscopy
XRD	- X-ray diffraction
WCA	- Water contact angle
D.I.	- De-ionized
RMS (R_a)	- Root mean square
PEM	- Proton exchange membrane
Avg.	- Average
AC	- Alternating current
DC	- Direct current
kV	- Kilo-volt
kHz	- Kilo-hertz
kW	- Kilo-watt
eV	- Electron volt
mm	- Millimeter

ABSTRACT

DBD plasma treatment for surface modification has been gradually finding attention in industrial application. Modifying surface property such as hydrophilicity on the stainless steel is growing popularity. For the fuel cell stack, stainless steel sheets are used, which were treated by an atmospheric pressure DBD plasma treatment source. The experimental set up was designed and developed in order to modify the surface properties of thin sheets to get optimum hydrophilic condition and higher surface energy with ageing effect. Five different surfaces were treated for different durations of time. DBD plasma discharge, parallel plate configuration was used with an air gap of four mm. A high voltage of 10kV was supplied for plasma discharge on to the surface of the sheets. Surface characteristics of the substrate were analyzed by using water contact angle and wetting energy analyzer; a goniometer, 3D nano surface profiler, field emission Scanning Electron microscopy (FE-SEM) and XRD.

After plasma treatment, the surface's average water contact angle and surface wetting energy were found to be improved. This was investigated for 14 days by using a goniometer and ageing in an air. Different substrates treated in different times, showed different results. The shorter the discharge time, the longer the hydrophobic recovering of the surface. The plasma surface treatments for five second shows the optimum condition for surface treatment of stainless steel at atmospheric pressure DBD plasma.

Key words: Dielectric barrier discharge, Atmospheric pressure plasma, Stainless steel, Ageing effect.

CHAPTER I

INTRODUCTION

1.1 BRIEF INTRODUCTION

Atmospheric pressure plasma is the current popular method of treating various kinds of substrates that widely focuses on industrial application such as food materials preservation to several aspects of biomedical and semiconductor technologies (1). In addition, the plasma processing is very flexible; usually it is possible to use certain experimental device for surface modifications of different kinds of material. Using atmospheric pressure plasma source is economical, convenient and safer than conventional vacuum technologies.

Atmospheric pressure plasma sources and configuration can include AC, DC, blown ion, microwave and DBD (dielectric barrier discharge) (2) The most successful commercial surface modification system like coating, sputtering, etching and cleaning of materials are DBD plasma discharge system. Source for the atmospheric pressure DBD plasma is typically AC in the range of kilovolt (kV) and low to medium frequencies (Hz) which operate around 125⁰C to 150⁰ C (3). DBD devices usually are designed with two parallel electrodes, either one or both covered with a dielectric barrier which can be organic or inorganic. DBD plasma at atmospheric pressure treatment only modifies the very thin layer near the surface up to some μm. The rest part of the material remains unchanged. It retaining bulk mechanical, physical, chemical and electro physical properties of the original material (4).

In this study, the application of DBD plasma on surface modification of the stainless steel sheet is to obtain the lower water contact angle or higher surface adhesion, which is used for the fuel cell stack as bipolar plate material. In the fuel cell, material subjects to continuous chemical reaction while generating electricity. Chemical corrosion, electrical resistance and weight are the foremost concern problems in the fuel cell (5). Researcher have found that stainless steel with thin film coating serve the best result to solve the existing problems, which has higher corrosive resistance, higher chemical stability and higher electrical conductivity. Prior to the surface coating, pre- treatment process is necessary to check the optimum hydrophilic and surface energy conditions of the material (6)

1.2 DIELECTRIC BARRIER DISCHARGE (DBD) AT ATMOSPHERIC PRESSURE

DBD is an effective and one of the most popular methods for generating low temperature plasma discharge at atmospheric pressure. DBD is highly non-equilibrium plasma that produces high-density active species including radicals, electrons and ions but still has moderate gas temperature around the substrate and attracted numerous attentions on the industrial uses.

The main features of the DBD plasma discharge is that non-equilibrium, non-thermal, silent plasma discharge in atmospheric- pressure and can be establish in very economical and reliable way compare to the low-pressure vacuum plasma discharge. (7)

Most of the DBD plasma discharges are filamentary and homogeneous discharge, which depends upon the experimental conditions such as gas type, pressure, electrodes gap, dielectric properties and applied voltage. Breakdown electron energy of 1eV to 10eV and AC voltage ranges up to several kV with varying frequencies in order of Hz to hundreds of kHz (8). Usually DBD configuration consist of two electrodes, at least one of them covered with a dielectric material such as Glass, Quartz Aluminum oxide, Titanium oxide and Ceramic but other insulating materials like thin polymer films, also can be used according to their application and operations as shown in figure 1. Recently, plasma metal pre-treated metal products have new applications in the field of food preservation, automobile industries, microelectronics, semiconductors and electromagnetic interference shielding materials (9) now it has wide application on the biological and medical fields too.

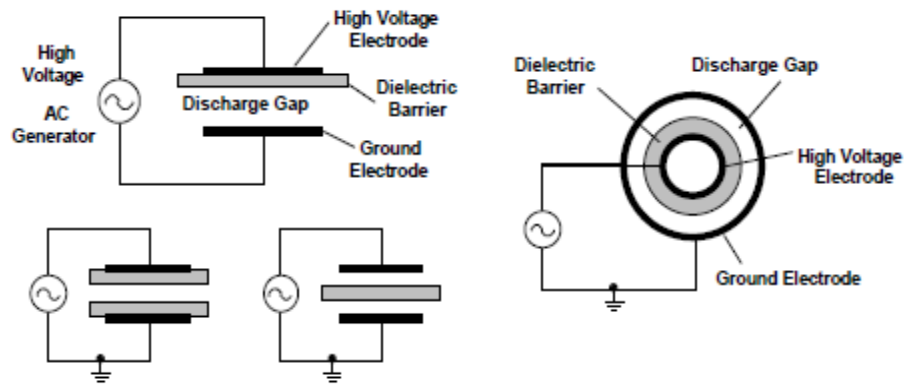

Figure 1. Common Dielectric- Barrier Discharge electrode configurations

1.3 SURFACE MODIFICATIONS WITH ATMOSPHERIC PLASMA

Commercial DBD system is mainly employed in industry for the modification of flat surfaces to attain wettability, printability and adhesion properties due to its convenience, effectiveness, and low cost (10). DBDs plasma treatment is used to produce hydrophobic or hydrophilic surfaces on the metals, plastics, glasses or polymers. For the typical hydrophobic surface modification NF_3 , C_4F_8 , CF_4 and hexamethyldisiloxane (HMDSO) and for the hydrophilic surface modification mainly inert gases or air is supplied to activate ions and electrons on the surface of substrates in atmospheric pressure plasma discharging zone (11).

Owing to the large number density of active radicals, it drastically raises the surface energy and enhances the wettability for water or other general chemicals. The surface energy and wettability changes can be evaluate by contact angle measurements by using goniometer.

Generally water at 20°C has surface tension 72.8mN/m (12) but its value changes according to the nature of the substrate's surface. Based on the surface energies of water and a substrate, the contact angle between them would change. With increased in the water angle, surface energy will decrease and the decreased of contact angle shows the increased of wetting energy and has greater. Figure 7 and 8 showed the water contact angles before and after the DBD plasma treatment at atmospheric pressure on the surface of stainless steel.

1.4 BENEFITS AND APPLICATION OF SURFACE MODIFICATION (ADHESION AND WETTABILITY)

Atmospheric pressure Plasma discharge is a relatively young technology and has many applications and benefits.

- It is much more economical and reliable technology as compare to the vacuum technology.
- Remove residual organic impurities and weakly bound organic contamination
- Improve surface coverage and spreading of coatings and enhance adhesion between two surfaces
- Modify wettability to render a surface hydrophilic or hydrophobic (figure 7 and 8) with appropriate processed gases
- Affects only few monolayers of the surface of substrate and does not change the bulk properties of the material
- Can be treated wide variety of materials as well as complex surface geometries like; semiconductor, glass slides oxides materials, mica polymers metal surfaces.
- Prepare surface for subsequent processing (such as thin film deposition or absorption of molecules, or prior to bonding or taking measurements)
- Used for dental implant and cleaning
- Treatment of biomedical devices and biomaterial prior to functionalizing surface

However, surface of substrate should be used as soon as possible after the plasma treatment; treated surfaces may recover their untreated surface characteristics with prolonged exposure to air (13).

1.5 FUEL CELL STACK AND STAINLESS STEEL

A fuel cell is an electrochemical device that converts hydrogen fuel directly into electricity and heat without combustion. To deliver the desired amount of electrical energy, numbers of fuel cells are combined to form a fuel cell stack. The greater the number of fuel cells greater the energy deliver. Flow field plates or bipolar plates are one of the major components in the fuel cell stock as shown in figure 2. They have to provide electrical connections between the individual cells, remove the water produced at the cathode effectively. They must be relatively impermeable to gases, sufficiently strong to withstand stack assembly and easily mass-produced, for transportation applications, low weight and low volume are essential. In operating conditions of the stack, high chemical stability and corrosion resistance are required. Oxides formed during corrosion can not only migrate and poison the catalyst but also increase the electrical resistivity of the plates, and therefore result in reduced fuel cell performance. (14).

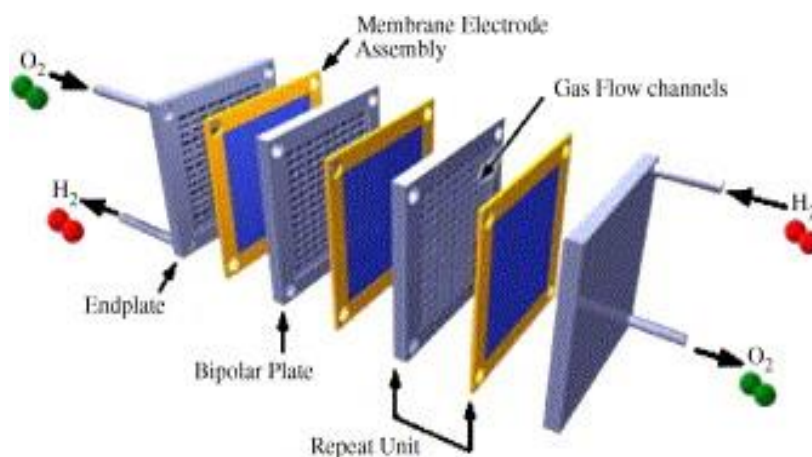

Figure 2 Exploded view of Fuel cell stack

The majority of PEM fuel cell stack producers utilize bipolar plates based on graphite. Now more attention has been paid to composites or metals. With many research shows, stainless steel over comes all the disadvantages and fulfill the requirement for the modern fuel cell stack.(15)

Steel represents a name of numerous alloys that consist of iron, carbon and other additives. The alloying process give the possibility of tune the properties of the final material and obtain superior mechanical, electrical and thermal characteristics, like high hardness, corrosion resistance, compression-tension stresses, thermal conductivity. Application of steel material is not only for good bulk mechanical properties but also use for surface properties. These might be wettability, high adhesion for coatings, biocompatibility and others.

Additional, Stainless steel is a low-cost material, it can be easily to manufacture sheets as thin as 0.1–1 mm, thus yielding a low volume stack. The material density is compensated by the possibility of using thin sheets.

Normally, stainless steel sheet needs to be coated in order to prevent corrosion, improve thermal and electrical conductivity. Hence, pre-treatment is needed to increase adhesion and high surface energy. Here, DBD plasma is applied to treat the surface of thin stainless steel to make more hydrophilic.

1.6 OBJECTIVES

Primary objective of the study was to find out optimum hydrophilic condition on surface of the stainless steel sheet by treatment of DBD plasma at atmospheric pressure.

Secondary objectives of the study were

- To observe optimum treatment time.
- To check surface roughness after treatment

1.7 MOTIVATION FOR THE STUDIES

During the last decade, the atmospheric pressure plasma systems have successfully made presence in the market especially for surface modification and cleaning applications. Making a transition from conventional vacuum plasma to atmospheric pressure plasma process, many researchers have achieved remarkable progress in DBD plasma surface modification, there is remain unsettled issues (16).

Being economical, safety, reliable; effectiveness of atmospheric pressure DBD plasma surface modification depends on various parameters like, AC power supply, flow rate of gas or air, gap between substrate and electrode, thickness of dielectric barrier, substrate material and physical structure.

Main motivating factor of this study is how we can treatment of thin sheet stainless steel of 0.1mm thickness and what is the surface morphology after the treatment of substrates. Stainless steel was treated on 10kV AC power supply for five different treatment time and check the hydrophilic condition of the surface during the different stages of time (ageing) to find out suitable, reliable, quick and long lasting DBD plasma treatment for the surface modification. In fact, that atmospheric plasma treatment in ambient air for the treatment of different surfaces of stainless steel is leading to aging of wettability was one of the motivated factors of this study.

CHAPTER II

MATERIALS AND METHODS

2.1 EXPERIMENTAL SET-UP

2.1.1 DIELECTRIC BARRIER DISCHARGE (DBD)

This concept of DBD plasma treatment on surface modification of thin stainless steel sheets, experimental setup was designed and fabricated for the horizontal movement as in figure 3, at the atmospheric pressure.

The system has a parallel-plate type of electrode configurations as shown in Figure 1. Plasma discharge is achieved between the ceramic dielectric barrier and ground electrode by applying a high voltage. DBD system used for this experiment. Upper plate has high voltage power supply line connection and below as ground connection. The area of discharge region is 100x80 mm², and two parallel electrodes were in four mm air gap as in figure 4. The AC power has been supplied through the AP plasma power supply, Dawonsys, Korea. The experimental test is set up at 10kV and 10 kHz, approximately 2 kW. There is no any gas is supplied externally throughout the operation. DBD plasma discharge was produced at the atmospheric air in the surrounding room temperature of 23⁰.

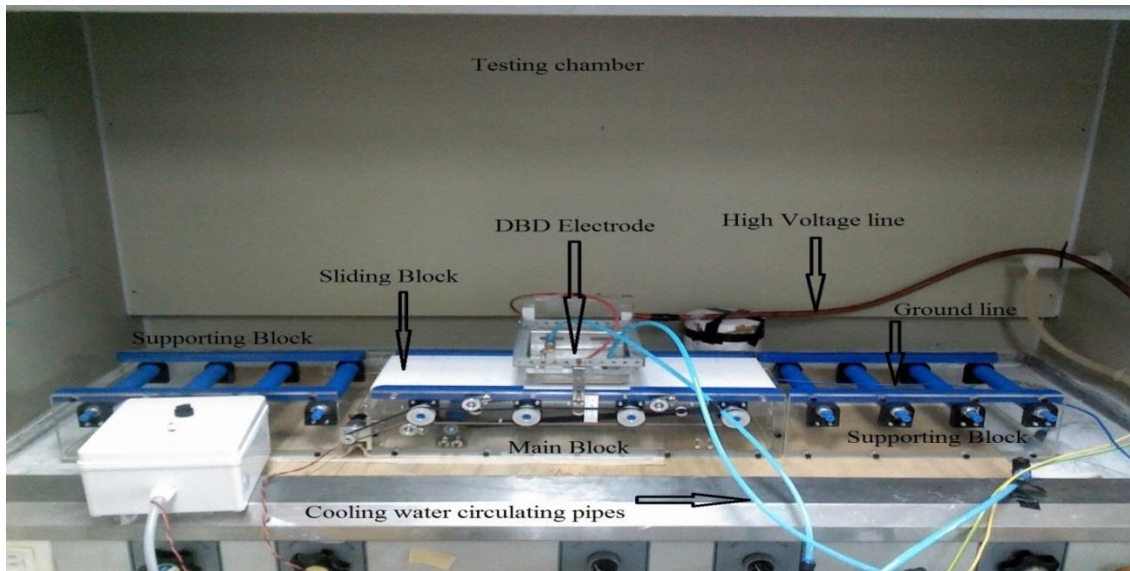

Figure 3. Designed & fabricated set-up for DBD plasma surface modification at atmospheric pressure

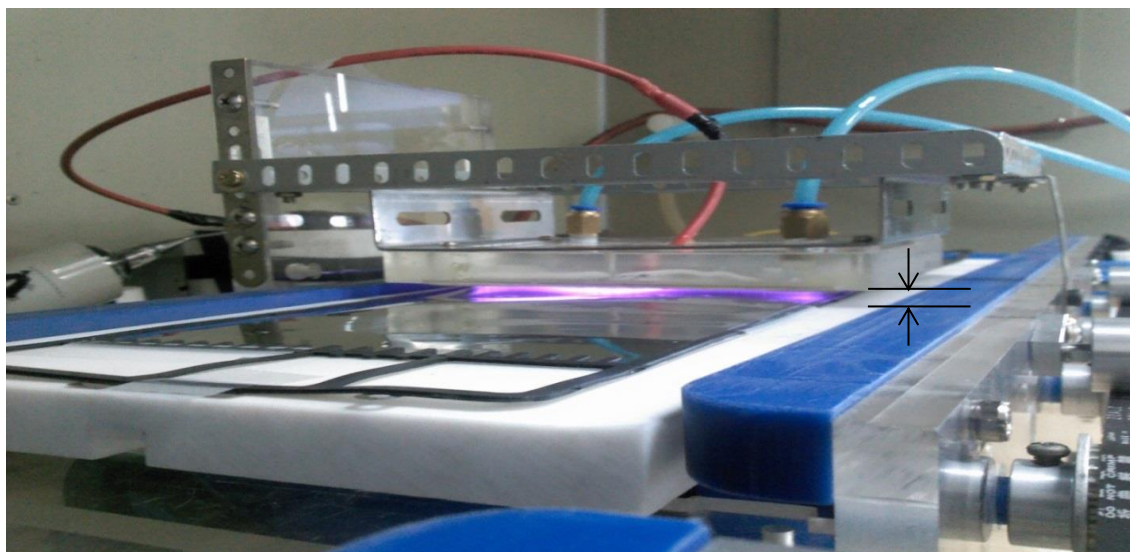

Figure 4. Typical plasma discharge on stainless steel in the gap of four mm

While in operation time, electrodes get heat up and might cause adverse effect on the surface treatment and plasma characteristics. De-ionized water has been used to transfer the heat from electrode and that de-ionized water again cool down to normal water temperature before pumping back to the electrode-cooling chamber again (figure 5). Normal tap water has less electric resistivity and D.I. water was use to avoid the risk of power leakage via the circulating tap water from the electrodes. It was important to keep the temperature of substrate constant to the treating large area of surface.

DBD plasma setup has a movable lower part made of Teflon block where stainless steel sheet has fixed and move through the air gap provided between two electrodes. Sheet was treated while passing through the discharge zone of plasma. Movement of Teflon block was provided by roller and belt attached to the gears and the speed controllable motor. Stainless steel sheet used for the surface modification was clean without any visible scratches 316L type of sheet. Directly took out from the package supplied from the manufacturing company. After treatment of five different stainless steel substrates in different time durations and kept in a vinyl case to protect from direct contact of air dust. Analyses were done by various instruments

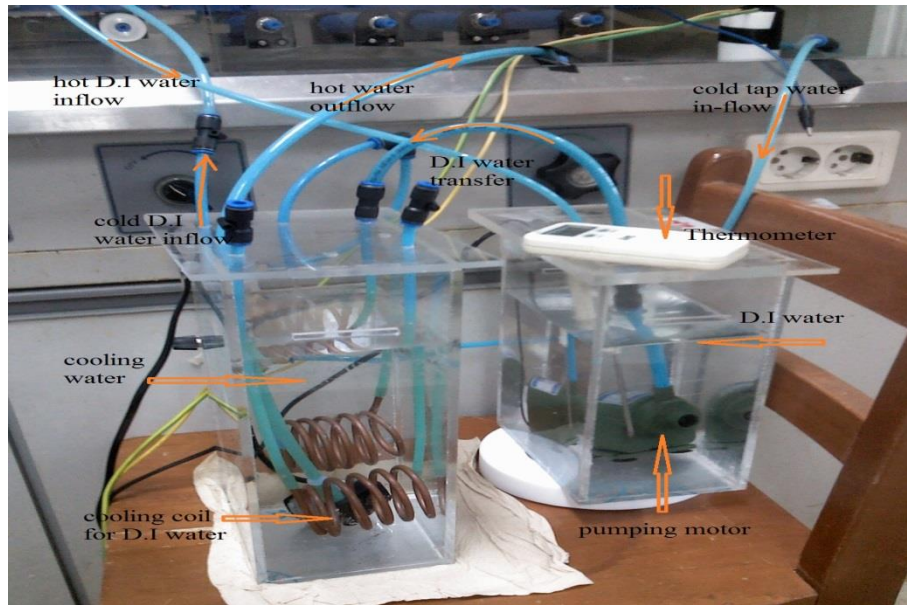

Figure 5. water-cooling system

This comprises of copper helical coil, pumping motor, flow rate measuring device, thermometer to check temperature of circulating de- ionized water and different lengths and size of water circulating pipes.

2.1.2 DIAGNOSTIC APPARATUS (INSTRUMENTS)

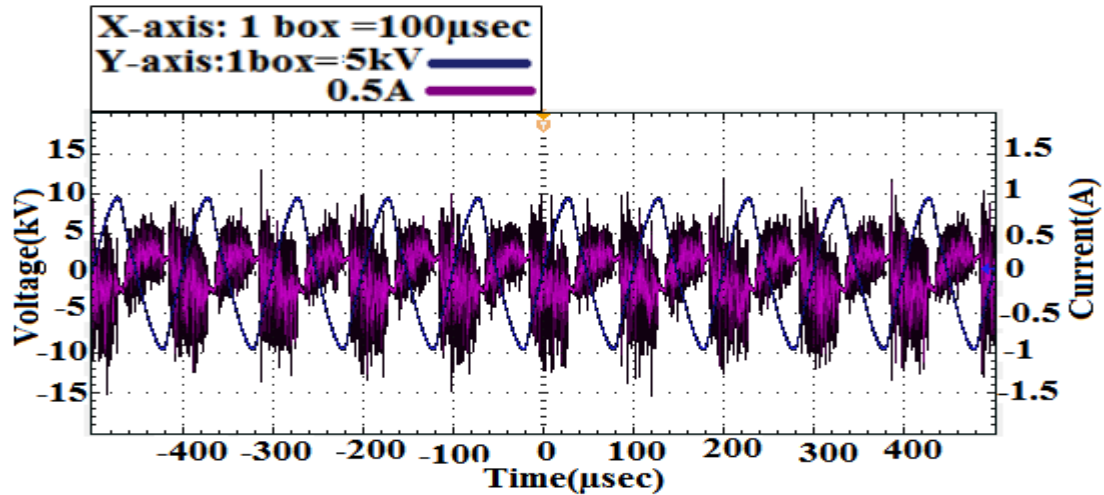

Figure 6. Image of oscilloscope of I-V characteristic at 10kV supply

Typical current-voltage characteristics was measured by connecting current probe to the ground line and voltage probe to high voltage line (Tecktronix P6021) as shown in figure 8. The shapes of the applied voltage and the discharge current were similar to sine waveform and a number of sharp peak forms respectively. The current shape was due to micro-discharges (17). the discharge currents in the upper and lower directions had different rates and also resulted from the dielectric material covers the upper electrode, whereas the other lower electrode was a bare condition. Thus, the source form can make the residual charges, i.e., the difference of barrier charges. Consequentially, the signal form of discharge current was induced as shown in figure 8.

Goniometer (Phoenix 300, SOE) was used to measure the average water contact angle by sessile drop technique. The water was dropped automatically by syringe approximately 6μL of water

per drop. The goniometer method was relatively straight forward and allows for the user to measure the contact angle with camera of a goniometer system. The droplet was deposited by a syringe pointed vertically down onto the sample surface and a high resolution camera captures the image, which image was analyzed by using image analysis software. The size of the droplet can be increased gradually so that it grows proportionally, and the contact angle remains congruent.

Surface morphology and conformity were observed before and after the treatment by using a JEOL, JSM-6700, field-emission scanning electron microscopy (FE- SEM) and Nano view high accuracy 3D nano no-contact surface profiler. XRD characterization was perform on an X-ray Diffraction system (D/MAX 2200H, Bede 200, Rigagu instruments)

Real metal surfaces usually may have rather high surface roughness due to manufacturing and post manufacturing processing, like rolling, polishing etc. The surface defects known as contaminants, scratches and micro cracks will accelerate localized corrosion. The value of RMS (R_a) roughness may varies from $1\mu\text{m}$ to $100\mu\text{m}$ peak-peak in same area. The surface roughness influences the spreading of droplets on the surface as well. The roughness measurement of real metal surface in not as easy as it may appear, because of numerous scratches present on the surfaces (16). In chosen stainless steel substrates, series of measurements were done to estimate the value of roughness by using 3D nano profiling system. Images were taken from five different points that don't have any visible scratches. The RMS roughness was calculated as average value from the images that we got for each samples. Fig .. are the six different substrates 2D and 3D images showing average RMS values. We can easily see the changes in surface roughness as shown in table 3.

CHAPTER III

RESULTS AND DISCUSSION

3.1 EFFECT OF AGEING TIME IN AIR OF PLASMA TREATED STAINLESS STEEL.

The ageing effects on the surface of stainless steel have observed from one hour to 14 days at 24 hours interval of time. Five sets of substrate were treated in 5 second, 10 second, 20 second, 30 second and 40 second time duration. Untreated SUS sheet shows the average-water contact angle of 72.76° and average-wetting energy 19.8 mN/m at room temperature of 23°C (Table 1 and 2).

Almost all substrates have similar contact angles between 10° to 12° and wetting energy around 70 to 71 mN/m after one hour of plasma treatment which is clearly seen in figure (7,8). This result has changed rapidly in 40 second treated substrate and reached contact angle 21.5° but the wetting energy has reduced to 67.69 mN/m in two days of aging time (Table 1 and 2).

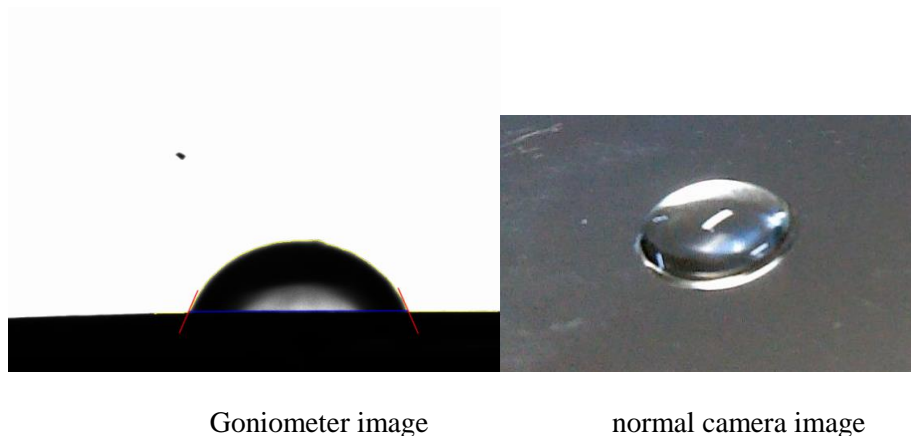
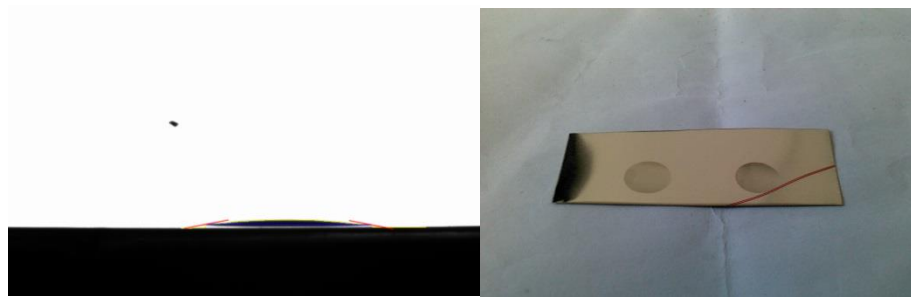

Figure 7, showing higher contact angle on untreated surface.



Goniometer image

normal camera image

Figure 8 showing lower water contact angle on DBD plasma treated surface.

After the 6th day of ageing time, 10 second treated substrate has shown higher average contact angle and lesser wetting energy than other substrates except 40 second treated (figure 10). However, contact angles raised suddenly in 7th day on 20s, 30s and 40s treated substrates. This trend has remained continuously till end of the experiment. In 9th day five second treated substrate has lowest contact angle and 40 second treated has highest contact angle (table 1) and corresponding wetting energy were 61.14 and 36.83 mN/m respectively.

At 10th day of aging time, water contact angle has increased drastically in five second treated substrate and reached 44.76° but at the same time 10 second treated substrate has minimum water contact angle (table 1). Wetting energy of these substrate were 51.46 and 59.66 mN/m respectively and 40 second treated substrate has lowest energy (32.85 mN/m).

Table 1 shows average water contact angle of substrate with respect to aging time
(hydrophobic recovery)

Sl. no.	Treatment time	Ageing Time after Treatment (Average water contact angle, degree)														
		1 hour	1 st day	2 nd day	3 rd day	4 th day	5 th day	6 th day	7 th day	8 th day	9 th day	10 th day	11 th day	12 th day	13 th day	14 th day
1	0 sec	72.76	72.76	72.76	72.76	72.76	72.76	72.76	72.76	72.76	72.76	72.76	72.76	72.76	72.76	72.76
2	5 sec	11.2	12.6	13.6	15.67	16.44	17.32	21.27	24.39	29.55	32.8	44.76	45.36	46.52	48.39	69.88
3	10 sec	11.5	13.21	13.81	16.52	18.81	26.87	28.91	31.55	32.51	32.99	34.96	36.61	43.67	45.43	49.60
4	20 sec	11.84	14.42	16.81	17.97	18.14	19.44	22.76	41.27	41.79	43.7	50.55	52.33	54.24	54.63	58.07
5	30 sec	10.6	14.55	16.14	17.49	19.66	22.46	26.56	37.28	40.31	40.63	41.72	44.38	51.73	55.32	62.31
6	40 sec	11.93	15.68	21.5	23.55	25.53	27.23	31.42	38.82	45.96	59.55	62.97	65.09	65.69	65.77	66.01

At 14th day of aging time, five second treated and 40 second treated surfaces have nearly similar value of wetting energy and contact angle with untreated surface (table 1 and 2). Comparatively lowest contact angle around 50^o and highest wetting energy of 47.18 mN/m were recorded in 10 second treated surface.

Table 2, showing average wetting energy of substrate with respect to aging time
(hydrophobic recovery)

Sl. no.	Treatment time	Ageing Time after Treatment (Average wetting energy, mN/m)														
		1 hour	1 st day	2 nd day	3 rd day	4 th day	5 th day	6 th day	7 th day	8 th day	9 th day	10 th day	11 th day	12 th day	13 th day	14 th day
1	0 sec	19.8	19.8	19.8	19.8	19.8	19.8	19.8	19.8	19.8	19.8	19.8	19.8	19.8	19.8	19.8
2	5 sec	71.41	71.03	70.76	70.09	69.82	69.39	67.84	66.32	63.21	61.14	51.46	51.14	49.93	48.03	25.03
3	10 sec	71.31	70.87	70.68	69.79	68.91	64.53	63.54	63.21	61.42	61.05	59.66	58.44	52.57	51.08	47.18
4	20 sec	71.24	70.51	69.62	69.24	69.18	68.53	67.13	54.62	54.27	52.61	46.11	44.42	42.54	42.06	38.49
5	30 sec	71.58	70.46	69.92	69.43	68.55	67.23	65.11	57.75	55.51	55.25	54.23	52.03	46.89	41.21	33.83
6	40 sec	71.21	70.19	67.69	66.73	65.68	64.71	62.13	56.69	50.61	36.83	32.85	30.64	29.95	29.87	29.61

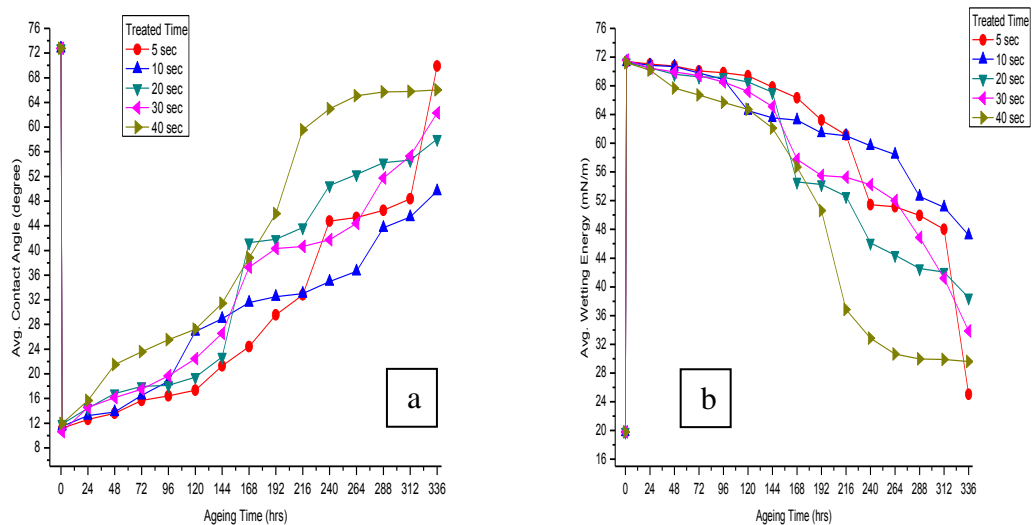

Figure 9. Effect of DBD plasma treatment on ageing time

a) average water contact angle (degree) vs ageing time (hours)

b) average wetting Energy mN/m vs ageing time (hours)

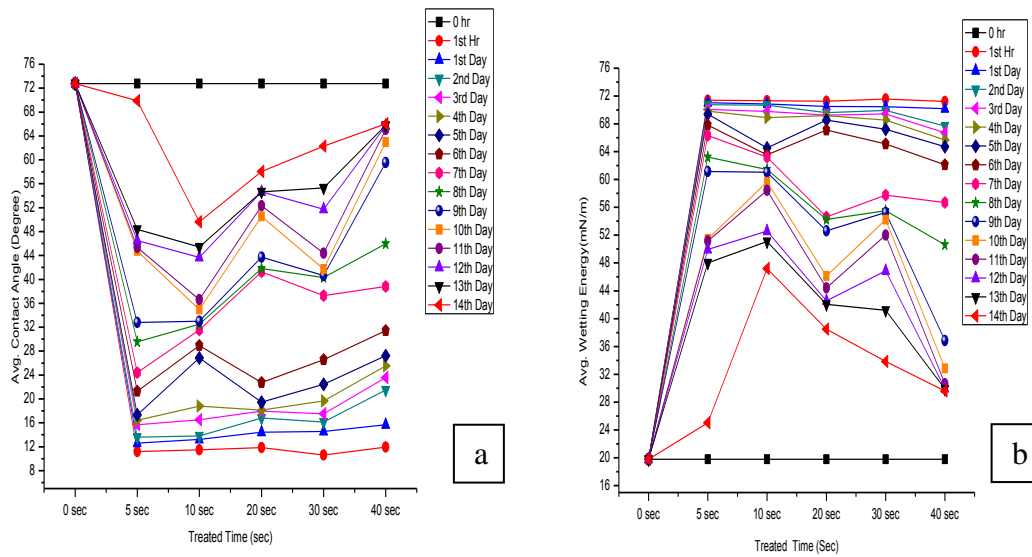

Figure 10. Effect of DBD plasma treatment on different time durations

- a) Average water contact angle (degree) vs various treatment time durations
- b) Average wetting energy (mN/m) vs various treatment time durations

During this study DBD plasma treated surfaces have lowest average water contact angle and highest wetting energy within one hour of treatment but longer time exposure in atmospheric air these values were found in gradual reverse order which were completely different than untreated substrates. My result was similar with Vadym Prysiazhnyi (16) in 5 second and 40-second treatment till 4th day of experiment.

The reason behind the decrease in contact angle during plasma DVD treatment could be the effect of surface chemistry. The amount of oxides, nitrides and radicals on the surface of stainless steel increased with extending the plasma treatment time, so the contact angles kept on decreasing (16), (18), (19). When the plasma treatment time as extended above certain time, the

oxides and nitrides on the surface would not increase further in spite they may transformed into non-active particles due to longer time exposure to the plasma (20). These non-active particles were thought to have adverse influences on the contact angle and further surface wetting energy did not increase any more. It is also considered that many oxides and nitrides could be generated during the process of exposure in air after plasma treatment, they could react with N_2 and O_2 in air and generate more oxides and nitride on the surface, which was beneficial for the surface wettability and WCA (21).

Ageing property is an important factor for maintaining high surface energy of treated materials. It is taken as important factor in industrial manufacturing and storage. Here, we discussed the ageing property of stainless steel surfaces, after plasma treated for different time interval. So far the observation of the effect of ageing time in air of plasma treated stainless steel surfaces for different interval of treatment time were not found in detail. Generally, stainless steels were found treated on the supplement of various gases based on DC source but this experiment has done using AC source of high voltage and high frequency in ambient air.

This study was focused on, how DBD plasma surface treatment at atmospheric pressure behaves, to check the hydrophilic condition of surfaces for some duration of time and find out the optimum condition for the DBD plasma treatment on the surface of the stainless steel. The recovery ratio of hydrophobic was different in different substrates treated for different time. It could be adsorption of air-born hydrocarbons and surface morphology of the substrate. But there were no valid support for these hypothesis (16).

In this experiment, at the beginning of the ageing process, the surface after the treatment was so activated that surface radicals could react rapidly increased in this period. With further extending the exposure time in air, the activated surface was more and more stable due to the reaction with stable components in air. Finally, the oxides and nitrides on the surface approached to the saturation state. At this saturated state, the water contact angle remained lower and wetting energy became higher, but further exposure time extended, the contaminations and stable components in the air would form undesired impurities on the saturated surfaces of the material and undesired compounds can make the surface more passive, which gives the adverse effect on the surface, causing increased in the WCA and decreased in the wetting energy gradually (22). The surface passivation caused by the long-term exposure to air would bring back to characteristic as the of untreated surface.

This study has suggested that 10 second time could be the best result for DBD plasma treatment on the surface of the stainless steel kept inside the container for 14 days. If the ageing of substrate observed for 9 days, five second could be the optimum and economic selection for treatment.

3.2 EXAMINATION OF SURFACE ROUGHNESS AFTER DBD PLASMA TREATMENT

The study of surface roughness on the stainless steel substrates were confirmed by images taken from 3D nano surface profiler system and a table shown below. These all images were taken one hour after the DBD plasma treatment at atmospheric pressure.

Table 3. Surface roughness and peak to peak values of six substrates treated on different durations of time(3D nano profiler)

Sl .no.	Treatment Time (second)	RMS (R_a)nm	Peak (R_t) μm
1	0 sec	169.61	2.79
2	5 sec	163.92	2.75
3	10 sec	152.93	2.72
4	20 sec	139.67	2.70
5	30 sec	138.06	2.60
6	40 sec	130.81	2.67

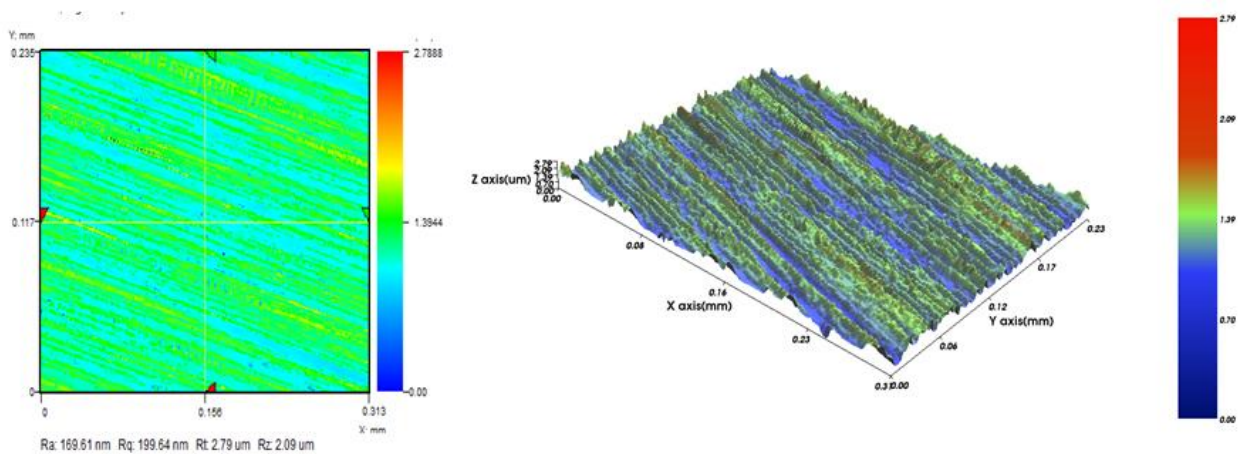

Untreated Surface (R_a 169.61nm, R_t 2.79 μ m)

Figure 11, 3D nano surface profiler image of untreated surface.

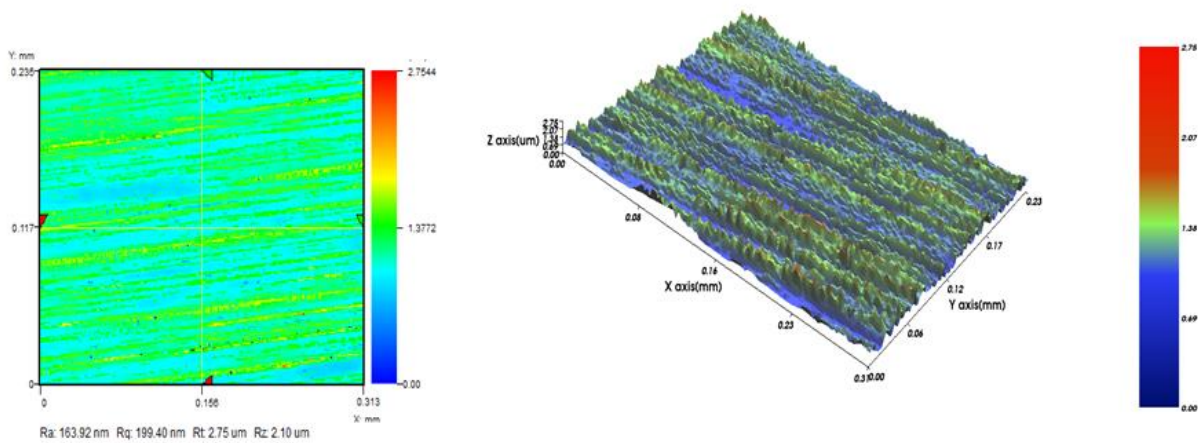

5 second Treated Surface (R_a 163.92nm, R_t 2.75 μ m)

Figure 12, 3D nano surface profiler image of five second DBD plasma treated surface.

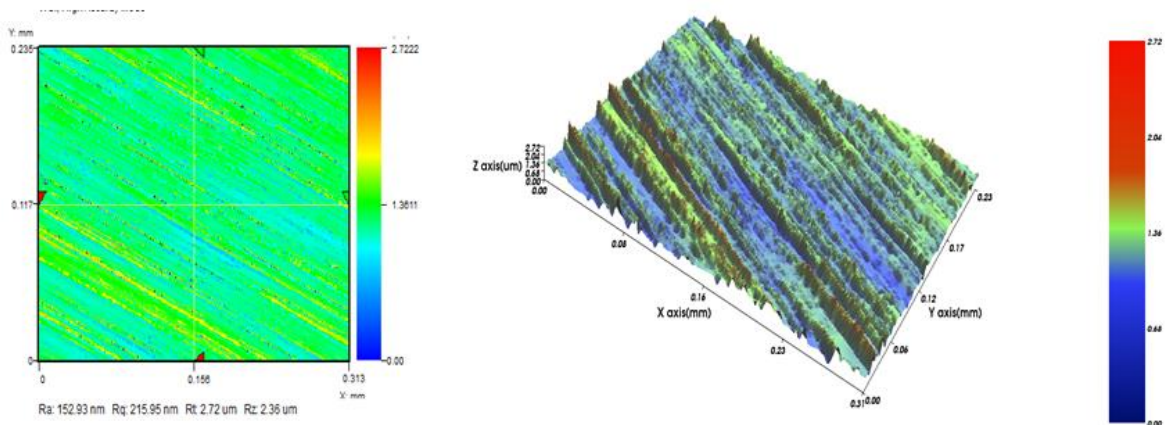

10 second Treated Surface (R_a 152.93nm, R_t 2.72 μ m)

Figure 13, 3D nano surface profiler image of ten second DBD plasma treated surface.

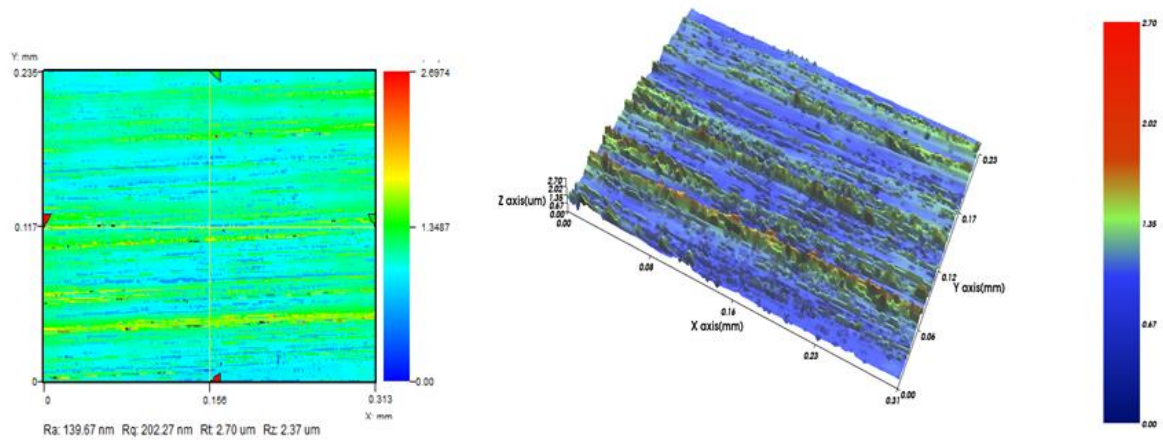

20 second Treated Surface (R_a 139.67nm, R_t 2.70 μ m)

Figure 14, 3D nano surface profiler image of 20 second DBD plasma treated surface.

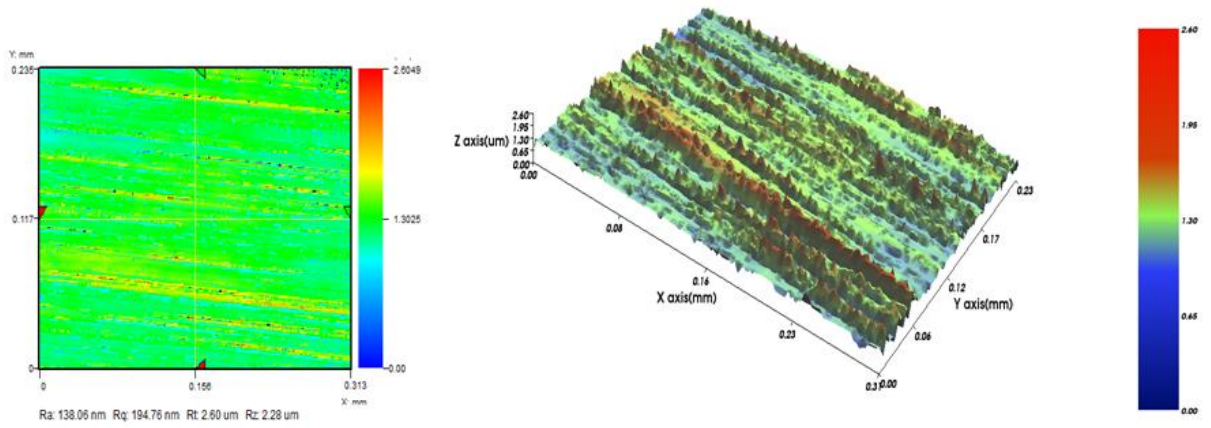

30 second Treated Surface (R_a 138.06nm, R_t 2.60 μ m)

Figure 15, 3D nano surface profiler image of 30 second DBD plasma treated surface.

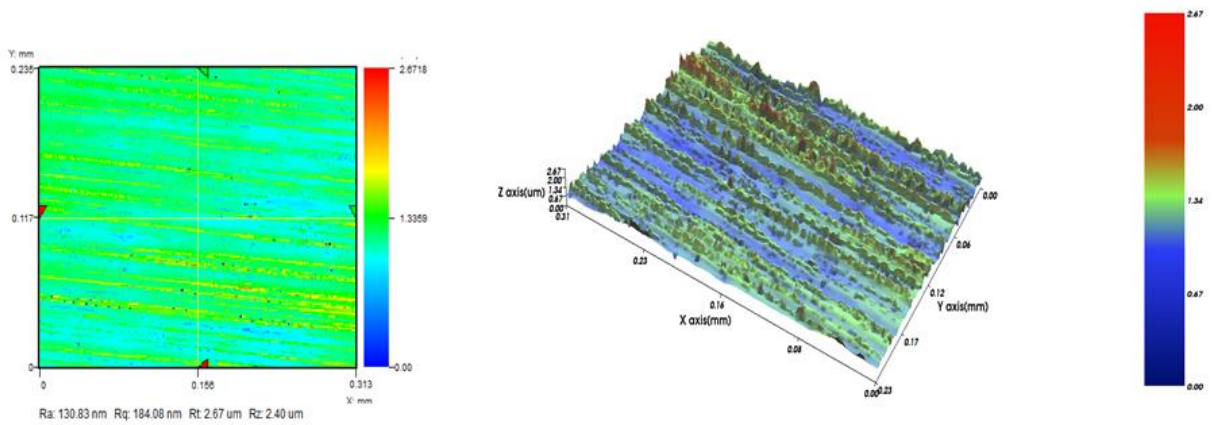

40 second Treated Surface (R_a 130.81nm, R_t 2.67 μ m)

Figure 16, 3D nano surface profiler image of 40 second DBD plasma treated surface.

Metal is considered to be a good material for bipolar plates for fuel cell stack due to its good electrical and thermal conductivity, excellent mechanical properties, low cost and flexibility. Typical metal such as stainless steel can easily meet requirement for the fuel cell stack material. It is hard and roughed material which has different physical characteristic than polymers and other non-metals, so it is not easy to change its physical characteristic easily. But with thermal and chemical reaction on the surface, properties of surface can be changed as our requirement (14)

The longer the Dielectric barrier discharge plasma treatment on surface, lesser the RMS value but Peak to peak value rises and become more rougher. This effect can be due to more cleaning effects and can be due to etching effect on the thin sheet of stainless steel. Longer discharge time, surface of thin sheet starts warping due to thermal expansion and surface can be etched easily with the bombardment of electrons, ions and radicals. 40second treated substrate had higher peak but lower RMS value than other substrates. Untreated substrate has highest peak and RMS value of all. In other substrate both values gradually decreases till the 40 second treatment of surface.

We can see on the images, hills and vallies are in parallel patterns. These are because of stainless steel physical structure. It is difficult to change the physical properties of steel within this short time of treatment. Surface properties can be changed by etching or cleaning or by chemical processes. It also found that surface roughness help to stick firmly into the surface while coating(23). Hence, it can be concluded that not all the surfaces roughness are disadvantages for the stronger and good coating effect.

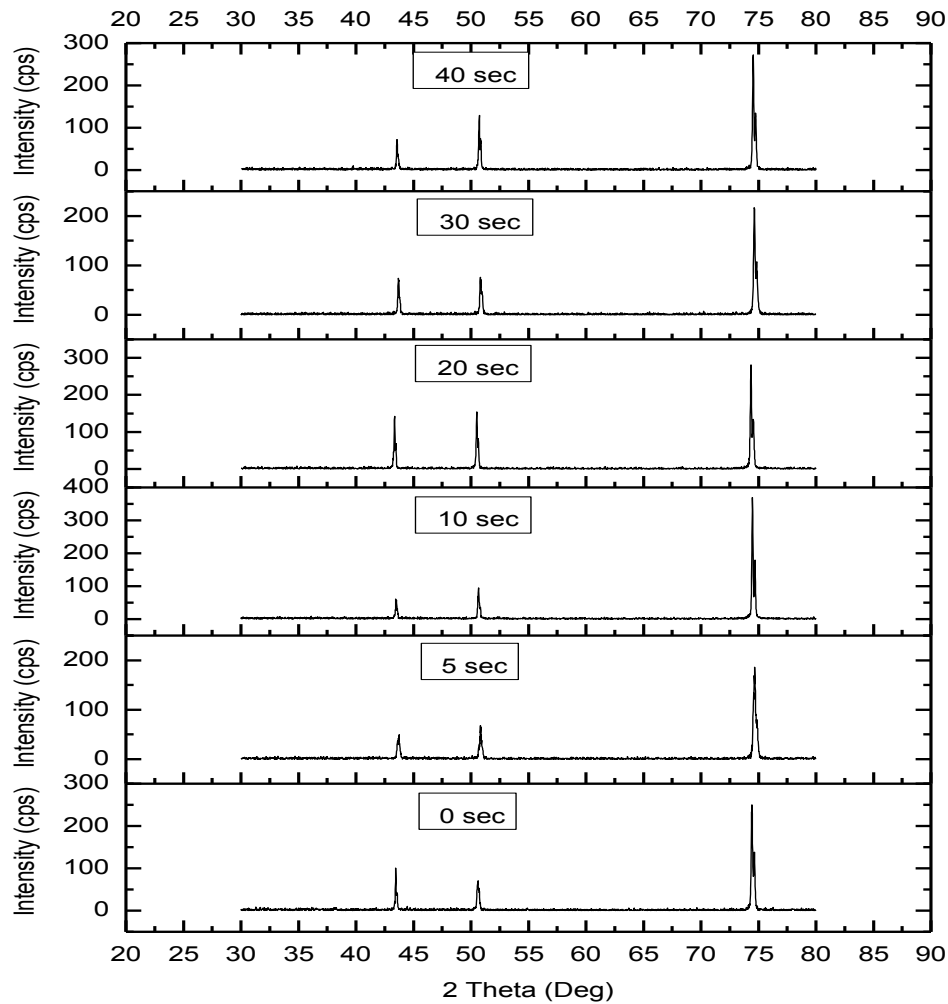

Figure 17. XRD result of six different substrates treated on various time intervals

We have already mention earlier, DBD plasma treatment on the surface of the stainless steel can only effect the some monolayers of few microns. In this study, no other gases has been supplied to enhance the DBD plasma characteristic for the modification of the surface properties and found no significant changes in crystallization structure or grain size of the thin sheet of stainless steel, investigating from the XRD (figure 17)

X-ray Diffraction image shows no significant changes in crystal grains. As we have previously discussed that stainless steel has tough surface can it is not easy to change its surface structure by DBD plasma treatment on the surface. Discharge can only changes it very thin layer of surface properties but bulk properties remain unchanged.

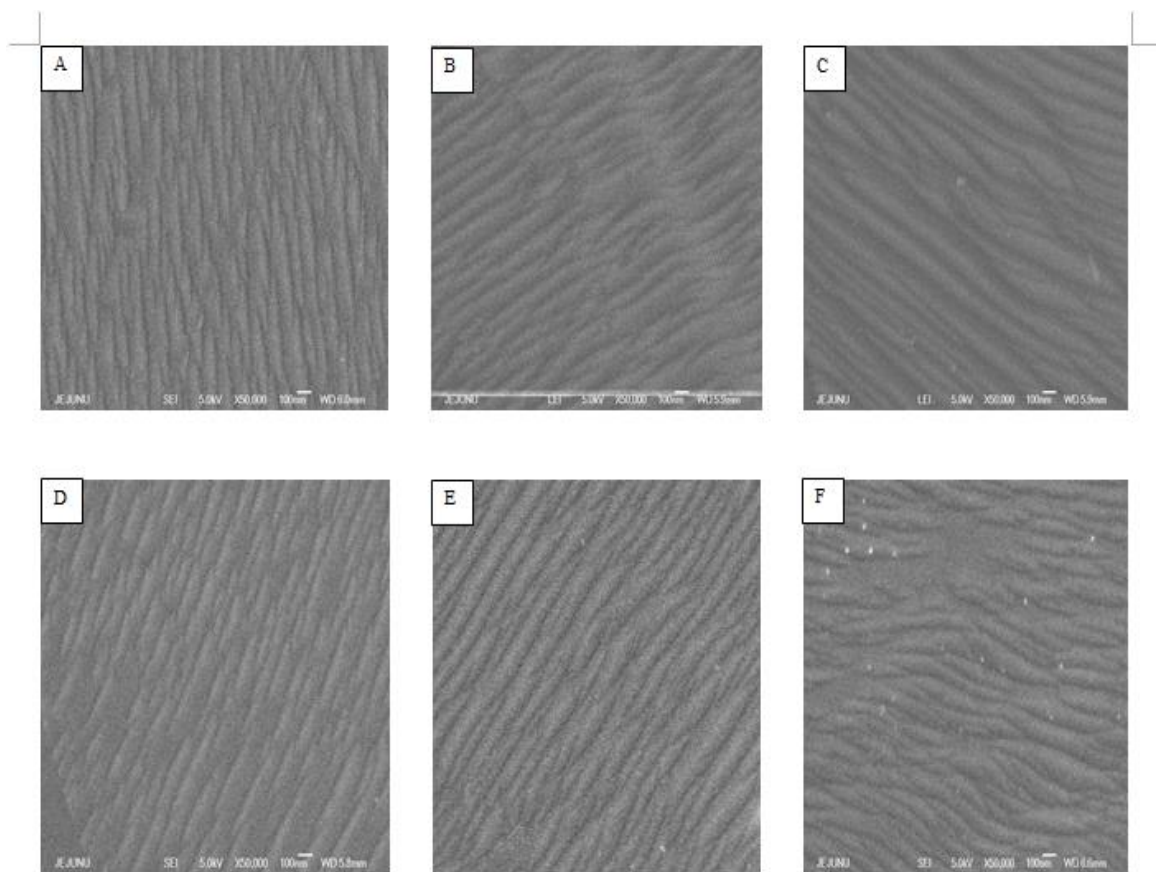

Figure 18. SEM images of treated and untreated stainless steel surfaces

FE-SEM (50000x magnification at Acceleration voltage 5kV) images for various treatment time of plasma on the surfaces of the stainless steel; a) 40 second treated substrate, b) 30 second, c) 20 second, d) 10 second, e) 5 second and f) is untreated substrate.

FE-SEM measurements revealed that no visible changes on the surface of the thin sheet of stainless steel after short time of DBD plasma treatment. As we have previously discussed that stainless steel has tough surface can it is not easy to change its surface structure by DBD plasma treatment on the surface. All the six images as shown in figure.. that were analyzed by the FE-SEM at 50000x magnification at Acceleration voltage 5kV. We could see only some patterns were became bigger and it could be due to cleaning and some etching effects on the surface of the substrate. Untreated substrate has some dots like visible white spots. It could be some dirt or impurities intact while in manufacturing processes (figure 18).

CHAPTER IV

CONCLUSION

A detailed study on application of DBD plasma treatment on surface modification of stainless steel at atmospheric pressure and ageing effects for several days on different substrates that were treated for different durations of time were successfully done. The goal of the study was to prove that the surface modification by application of dielectric barrier discharge plasma can be utilized for the stainless steel optimum treatment time and best storage time as well as other related surface behaviors.

Surface roughness, analyzed by the 3D nano profiler was changes with the treatment time. We have seen from the SEM and XRD images, there were no significant changes can be noticed, but little bit of patterns and peaks differences in the images can be seen. It could be due to cleaning and some opening of mechanical interlocking between the grain sizes. stainless steel microstructure is very compact and from the dielectric barrier discharge plasma treatment have less impact on the physical properties.

The analysis proved that plasma treated surfaces for short time have best water contact angle and wetting energy for the modification of surface properties, which were exposed to several days in an ambient air at room temperature. Five second treated stainless steel substrate at the supply of high voltage 10kv and the air gap of four mm between the electrodes, shows the lesser water contact angle and higher wetting energy than any other substrates during the ageing time.

Hence, it can be concluded, that five-second DBD plasma treated surface at atmospheric pressure and exposed to the ambient air until 9th day after the treatment is better to use as fuel cell stack material.

ACKNOWLEDGEMENTS

First of all, I would like to thank my supervisor, Professor Heon-Ju Lee. I will always be indebted of him for all his kind support, supervision. This work would not have been possible without his guidance, encouragement and interest throughout my master course. Coming from the mechanical engineering field, plasma application technology was much unknown to me, but prof. Lee gave me opportunity to learn and to broaden my knowledge in this field of plasma application. I owe him lot of gratitude for having me shown this way of research. He could not even realize how much I have learned from him. Besides, of being an excellent supervisor, Prof. Lee was as a guardian to me. I am glad to get know Prof. Heon-Ju Lee in my life.

I would like to express my lots of thanks and gratitude towards Prof. Wong Gee Chun and Prof. Young-Sun Mok, I took several courses under them and learned lot of from their courses which were blended of theoretical and practical knowledge. They gave me chances to carry out some of my experimental work in their laboratory. Without their permission, I would not complete my work.

I like to thanks to my lab members Dr. Lyakhov Konstantin, Dr. Ulugbek Shaislamov. Lots of thanks to Muhamad Waqar Ahmed, who helped me in so many ways during my study, especially on theoretical parts. Thanks to my other lab mates Jong Keun Yang, Seung Hyeon Kim, Min Gyu Oh, Md. Shahinur Rahman for their help.

I should not forget to give special thanks and gratitude to Pradeep Adhikari, Tran Anh Thao and Trinh Quang Hwng, without their helps and supports my work would not be complete. They gave me pleasant memorable times and supports during my stay in Jeju National University. Their friendship will remain for my lifetime.

I am glad to have friends in Jeju National University who always made me believe they are there when it matters and has been part of my happiness and hard ships. My heartiest thanks go to all my friends from Vietnam, India, and Pakistan. Especially I like to thanks DB, who stood beside me all the time to support, encourage and to help me in every aspects. I would like to thank all those whom I have not mentioned above but helped me in numerous ways to my success

I am grateful to the staffs of department of nuclear and energy engineering for sharing information and helping me in official issues

It is my great honor to thanks to Brain Korea 21plus project (BK21⁺) under the Korean Government, who provided me kind and generous financial assistance to carry out my study.

Finally, I will never find words enough to express the gratitude that I owe to my parents, sisters, relatives and friends. Their tender love and affection has always been the cementing force for building the blocks of my academic career. They are the backbone my all my work, my strength.

REFERENCES

1. Roth JR. Industrial plasma engineering, Volume 2, Application to nonthermal plasma processing. Institute of Physics; 2001.
2. Borcia G, Chiper AS, Mihaila I, Vitelaru C, Popa G. Atmospheric-pressure dielectric barrier discharge in He and He + O₂ for surface modification of polymers. 2011;28–31.
3. R.A. Wolf. Atmospheric Pressure Plasma for Surface Modification. 1 edition. Wiley-Scrivener; 2012.
4. Fridman G, Shereshevsky A, Jost MM, Brooks AD, Fridman A, Gutsol A, et al. Floating Electrode Dielectric Barrier Discharge Plasma in Air Promoting Apoptotic Behavior in Melanoma Skin Cancer Cell Lines. Plasma Chem Plasma Process [Internet]. 2007 Mar 2 [cited 2014 May 23];27(2):163–76. Available from: <http://link.springer.com/10.1007/s11090-007-9048-4>
5. LI X, SABIR I. Review of bipolar plates in PEM fuel cells: Flow-field designs. Int J Hydrogen Energy [Internet]. 2005 Mar [cited 2014 Jun 2];30(4):359–71. Available from: <http://www.sciencedirect.com/science/article/pii/S0360319904003453>
6. Liu Z, Chen P, Zhang X, Yu Q, Ma K, Ding Z. Effects of surface modification by atmospheric oxygen dielectric barrier discharge plasma on PBO fibers and its composites. Appl Surf Sci [Internet]. 2013 Oct [cited 2014 May 26];283:38–45. Available from: <http://linkinghub.elsevier.com/retrieve/pii/S0169433213010775>

7. Kogelschatz U. Dielectric-barrier discharges: Their History, Discharge Physics, and Industrial Applications. *Plasma Chem Plasma Process*. 2003;23(1):1–46.
8. Gulati P, Pal UN, Kumar M, Prakash R, Srivastava V, Vyas V. Diagnostic of plasma discharge parameters in helium filled dielectric barrier discharge. 2012;1–8.
9. Kim MC, Song DK, Shin HS, Baeg S-H, Kim GS, Boo J-H, et al. Surface modification for hydrophilic property of stainless steel treated by atmospheric-pressure plasma jet. *Surf Coatings Technol* [Internet]. 2002 Jul [cited 2014 May 23];171(1-3):312–6. Available from: <http://linkinghub.elsevier.com/retrieve/pii/S0257897203002925>
10. K.H Becker, U.Kogelschatz K. shoenbach and R. B. Non-eeuilbrium air plasma at Atmospheric pressure. *Institue Phys Publ*. 2004;
11. Wang FJ, Lei S, Ou JF, Xue MS, Li W. Superhydrophobic surfaces with excellent mechanical durability and easy repairability. *Appl Surf Sci* [Internet]. 2013 Jul [cited 2014 May 26];276:397–400. Available from: <http://linkinghub.elsevier.com/retrieve/pii/S0169433213005898>
12. Wikipedia. Surface tension. http://en.wikipedia.org/wiki/Wetting#Wetting_of_low-energy_surfaces.
13. J.A. Bittencourt. *Fundamentals of Plasma Physics*. Third Edit. Springer International Edition; 2013.
14. Zi X, Wang H, Zhang J, Wilkinson DP. Bipolar Plates for PEM Fuel Cells - From Materials to Processing. 2006;267(2005):257–67.

15. D. P. Davies, P. L. Adcock, M. Turpin SJR. *J. Power Sources*, *JPower Sources*, 2000;86.
16. Vadym Prysiashnyi. Ph.D. Dissertation. Dep Phys Electron Fac Sci Masaryk Univ. 2012;121.
17. Wang C, Zhang G, Wang X, He X. The effect of air plasma on barrier dielectric surface in dielectric barrier discharge. *Appl Surf Sci* [Internet]. Elsevier B.V.; 2010 Dec [cited 2014 May 26];257(5):1698–702. Available from: <http://linkinghub.elsevier.com/retrieve/pii/S016943321001216X>
18. Shi T, Shao M, Zhang H, Yang Q, Shen X. Surface modification of porous poly(tetrafluoroethylene) film via cold plasma treatment. *Appl Surf Sci* [Internet]. Elsevier B.V.; 2011 Dec [cited 2014 May 26];258(4):1474–9. Available from: <http://linkinghub.elsevier.com/retrieve/pii/S0169433211015133>
19. Thongyai N, Daowphiset S, Pungwiwat N. Study of Stainless Steel Surface Cleanability. (2):2–4.
20. Tang S, Kwon O-J, Lu N, Choi H-S. Surface free energy changes of stainless steel after one atmospheric pressure plasma treatment. *Korean J Chem Eng* [Internet]. 2004 Dec;21(6):1218–23. Available from: <http://link.springer.com/10.1007/BF02719497>
21. Suzuki, M., Kishida, A., Iwata, H, Hata, Y. and Ikada Y. Graft copolymerization of Acrylamide onto a polyethylene surface pretreated with a glow discharge. *Macromolecules*. 1986;19:1804.

22. Wang C, He X. Effect of atmospheric pressure dielectric barrier discharge air plasma on electrode surface. *Appl Surf Sci* [Internet]. 2006 Nov [cited 2014 May 26];253(2):926–9. Available from: <http://linkinghub.elsevier.com/retrieve/pii/S016943320600078X>
23. Cui N-Y, Upadhyay DJ, Anderson C a., Brown NMD. Study of the surface modification of a Nylon-6,6 film processed in an atmospheric pressure air dielectric barrier discharge. *Surf Coatings Technol* [Internet]. 2005 Mar [cited 2014 May 26];192(1):94–100. Available from: <http://linkinghub.elsevier.com/retrieve/pii/S0257897204001835>

석 . 박사 학위논문 등표지

	<p>Application of DBD plasma treatment on surface modification of fuel cell stack at atmospheric pressure •</p> <p>Suresh Rai • 2014</p>	
--	--	--